

The customer magazine of the INDEX Group

TURNINGpoint

07
2020



better.parts.faster.



Reiner Hammerl, Dr. Dirk Prust, and Harald Klaiber
INDEX Group Executive Management (from left to right)

Take advantage of the opportunities now!

Dear customers and friends of the company,

Who, just one year ago, would have suspected that the downturn in the automotive industry's fortunes would be completely overshadowed within such a short time by the effects of the Covid-19 pandemic? After the great burdens that the corona crisis has imposed on so many companies over recent months, it is now time to look ahead once more and take advantage of the opportunities – which undoubtedly exist.

For one thing, catch-up effects – both in the private and commercial consumption of goods – will ensure a revival of traditional business sectors. In addition, the changed general environment will gradually lead to new products that will open up growth opportunities in just the near future.

Despite these difficult economic times, we have continued to develop new machines and software products. For the first time we were presenting the results to you during our iXperience days.

A CNC multi-spindle lathe, the INDEX MS24-6, is the first new development to be mentioned in this context, and is the result of the further evolution of the successful INDEX MS22-6. Optimized performance data with the new fluid-cooled spindle drum and the tool holder quick-change system already introduced with the current INDEX MS32-6 are probably the most striking innovations. The beneficial effects of the improved accuracy and setup time will further increase the cost-effectiveness of this machine overall.

As a further highlight, we will be presenting the second generation of the TRAUB TNL12 sliding headstock automatic lathe. Thanks to more advanced kinematics, now with four tool carriers that can be used simultaneously yet independently from one another, this machine generation opens up significant potential for reducing part production times. What is more, the programming options have been made even more efficient – and all of this with a footprint that is unchanged compared to the first generation.

The TRAUB TNA500 will be also presented for the first time. This machine rounds out the product portfolio of INDEX and TRAUB universal turning machines with its increased drive power.

The new iXcenter “XL” robot automation cell is used on the machines in the INDEX G400/G420 series, and expands the family of standardized INDEX automation solutions. The INDEX G400 with three turrets will also be presented here for the first time.

As an “Industry 4.0” platform, INDEX iXworld has already established a leading place for itself in the area of i4.0 solutions. In particular, users appreciate the practical approaches we have pursued to increase OEE. We will also be demonstrating further ways to improve efficiency with numerous new apps.

We hope that you enjoy reading about the latest machines, technologies, services and applications that we have developed to support your success. **X**

Highlights

Productive manufacturing solutions

Long and heavy? No problem –
the new INDEX G400 turning center 04

The new TRAUB TNL12 sliding and fixed
headstock automatic lathe for precise machining
of small workpieces 24

Reduce setup times and cut unit costs
with the new INDEX MS24-6 multi-spindle
automatic lathe 34

Innovative technologies

Automation from S to XL
with the INDEX iXcenter robot cell 08

Ideally prepared for the future –
INDEX iX4.0 IoT platform news 20

Manufacture polygons with ease – innovative
production options for polygon turning 40

Successful together

A visit to TEST-FUCHS, the successful
Austrian manufacturer of test equipment
for the aerospace industry 12

Innovative medical technology in the clean room –
a visit to AMI in Feldkirch/Austria 30

AWA goes “iXshopping” –
Amaturenwerk Altenburg reveals how it success-
fully organizes its procurement processes 22



Long and heavy? No problem

Following the successful market launch of the new, large INDEX G420 turn-mill center in the spring of 2019, the stage is now set for the INDEX G400 variant. This turning center, designed for complete machining of workpieces up to 2,300 mm long, replaces the motorized milling spindle with a VDI-40 turret containing twelve stations.

INDEX G400 turning center

Do you need to carry out complete machining on parts up to 2,300 mm long, primarily requiring turning and live tools for drilling and milling? If you do, our new INDEX G400 turning center is the ideal solution. While its counterpart, the INDEX G420, has its upper tool carrier designed as a motorized milling spindle with a large tool magazine, the INDEX G400 uses a robust VDI-40 tool turret with twelve stations.

A particular feature of this turret is its polygon quill, which can absorb high forces and enables a large Y stroke of ± 100 mm. The hardened quill material, which is given a special texture, and the sliding guide together ensure excellent damping qualities. The live tools in the upper turret deliver impressive drilling and milling results thanks to a 7.5 kW motor with 35 Nm torque – supported by the unique INDEX W-serration system for incredibly fast, accurate and repeatable tool changes.

Sturdy machine design, premium components

The INDEX G400 builds on the premium quality of the INDEX G420. The mineral cast bed in block design is extremely rigid and, together with the generously dimensioned linear guides in the X

and Z-axes, ensures excellent stability and damping properties. In addition, by having a ratio of stationary to moving masses of more than 5 to 1, the machine delivers not only excellent rigidity but also outstanding dynamic properties.

Even in the standard version of the INDEX G400, the two lower VDI-40 tool turrets can be moved ± 70 mm, not only in the X and Z directions, but also by means of a linear Y-axis. They each provide twelve tool stations, all of which can be equipped with live tools. An option with eighteen stations each is also available if more tools are required, though there is no Y-axis in this version.

The INDEX G400 features fluid-cooled main and counter spindles – identical in size A8 or A11 (spindle clearance $\varnothing 102/\varnothing 120$ mm, chuck size 315 mm/400 mm). With their high dynamics, power, and torque (A8: 41 kW, 920 Nm/A11: 43 kW, 1,000 Nm), they are ideal for high-performance turning operations. Thanks to the large distance between the spindles and the generously dimensioned work area, all three tool turrets can be used simultaneously on the main and counter spindles without any risk of collision. ➤

The INDEX G400 control system is based on a Siemens Sinumerik 840D SL. Simple and safe operation is ensured by an 18.5" touch terminal and the INDEX iXpanel cockpit system, which makes it easy for users to integrate their machines into existing network structures and use INDEX's own IoT platform iX4.0.



Three cutting edges in simultaneous use. Ideal for high-performance, productive machining of long and heavy flange and shaft parts in a generously dimensioned work area.



One highlight of our new INDEX G400 turning center is the Y quill on the upper turret, where we have invested a great deal of development expertise. It is based on a polygon contour that can absorb high forces and impresses with its excellent damping properties and minimum friction.

Ulrich Baumann is the Head of Development and Design of Single-Spindle Automatic Lathes at INDEX



Numerous configuration options

The standard turning length of the G400 is 1,600 mm. If you need more, INDEX also supplies a long version with a turning length of 2,300 mm.

The wide range of equipment options ensures ideal results for machining solutions in industries such as energy, agriculture/mining, aerospace, offshore, naval, and many more.

Automation solutions

To enable automated operation of the G400, INDEX offers two different integrated handling units for loading and unloading small to medium-sized parts weighing up to 20 kg, as well as for removal of remnants.

The iXcenter is ideal for higher workpiece weights. This high-end robot automation solution enables even greater flexibility. The brand-new iXcenter is presented in the next article. ✕



INDEX G400 machine highlights

- ▶ Three tool carriers in simultaneous use
- ▶ Identical main and counter spindles A8 ($\varnothing 102$ mm/ $\varnothing 315$ mm) or A11 ($\varnothing 120$ mm/ $\varnothing 400$ mm)
- ▶ Maximum turning length 2,300 mm
- ▶ Unique Y quill on upper turret
- ▶ High thermal and mechanical stability
- ▶ High dynamic response (rapid traverse rate up to 50 m/min)
- ▶ Numerous configuration options
- ▶ Engineering excellence "Made in Germany"



Watch the film now:
 > index-traub.com/g400-video

info

Automation from S to XL

The INDEX **iXcenter robot cell** is now also available in an XL version for large INDEX turn-mill centers. Thanks to its flexible design, the modular automation system can be used not only for loading and unloading large, heavy workpieces, but also for a range of upstream and downstream tasks.

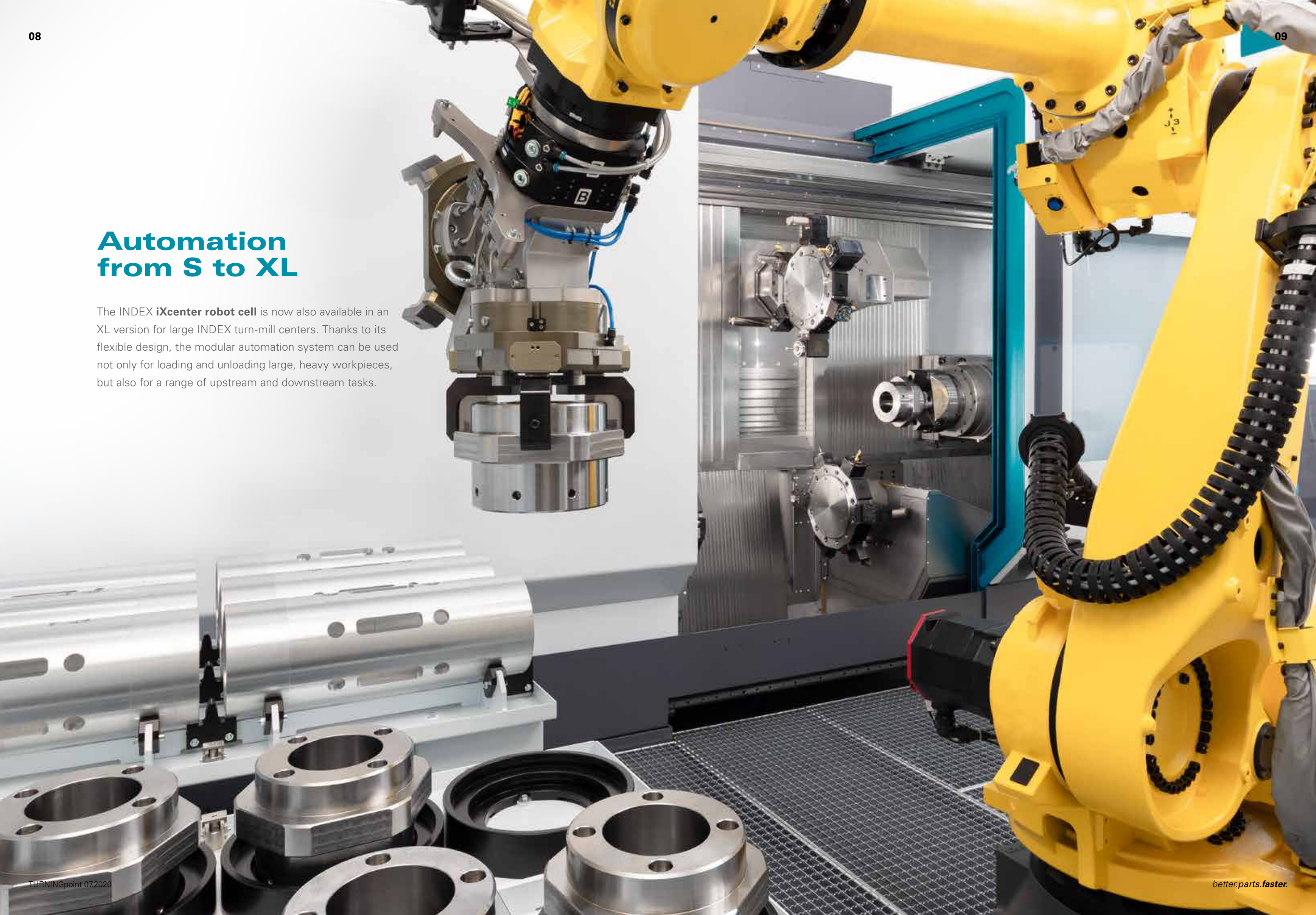

Robot cell *Xcenter*

Where would modern machine technology be today without the right automation solution? Strong demand for automation solutions is being seen across the entire machine range. In addition to established workpiece handling units, interest in the iXcenter robot cell has grown considerably.

Automation cells for the small and medium-size machine segment

The first iXcenter was developed in 2016. The version for the compact TRAUB TNL20 sliding/fixed headstock automatic lathe, which is fully integrated in the machine, essentially consists of a jointed-arm robot and a vertical pallet storage unit with up to 14 pallets (300 x 400 mm). Chucked parts can be loaded and unloaded with the robot, and finished components can also be discharged following bar machining. In addition, this iXcenter is already prepared for the integration of additional process steps such as 3D measuring and deburring.

With medium-size machines such as the INDEX C100 and C200 production turning machines, the INDEX G200 turn-mill center, and now also the TNA and B-series universal turning machines, the iXcenter is located on a platform equipped with linear guides and fixed in front of the machine's work area during production. The 6-axis robot (up to 12 kg load capacity) accesses the machine's work area via the machine door, which opens automatically behind the robot cell.

How XL automation works

The newest iXcenter automation solution was developed for the turn-mill centers in the large G-series. Automation plays an important part in machines of this size (turning length up to 1,600 mm/2,300 mm), as the operator requires support during loading and unloading due to the weight of the parts. An investment in an automated handling unit for this size of machine quickly pays for itself.

A modular design was selected for the large iXcenter. The automation solution is essentially comprised of a large autonomous standard robot cell positioned in front of the machine – a base unit featuring a jointed-arm robot with a load capacity of 165 kg as standard (optionally up to 270 kg). Different modules can be docked to this cell from two sides, including pallet/rack

systems, measuring/testing stations, equipment for deburring, cleaning or laser marking, and much more. The XL version of the iXcenter is easy to access.

This means that the robot is not only responsible for loading and unloading the parts via the machine door, but can also deal with upstream and downstream processes during what are often long machining times, thereby reducing employee workloads in various ways. **X**



➤ Even in the standard version, our large iXcenter solution covers a wide range of tasks, such as the robot's gripper change. Many different tasks can be implemented as part of the customer solution.

Benjamin Baron
is Head of Automation at INDEX





Quality at all levels

TEST-FUCHS, based in Groß-Siegharts in Austria's Waldviertel region, machines demanding materials in the manufacture of test equipment for the aerospace industry – from high-quality aluminum alloys, hard-to-machine stainless steels, and engineering plastics to Teflon and titanium. They do this with the greatest precision and in limited and small production runs of up to 300 parts. By investing in the INDEX R200 and INDEX G200 turn-mill centers, the management believes the company is well equipped to meet demand – now and in the future. **By Helmut Angeli**

The name TEST-FUCHS is a byword for highly specialized test systems and components for the aerospace industry. Its product range includes a wide range of test equipment for hydraulic, fuel, electrical, and pneumatic systems for well over 100 aircraft types.

"We don't, however, just produce testing facilities and ground support equipment," says CEO and Managing Partner Volker Fuchs, "but also 'flight' components such as pumps for controlling fuel, lubricating oil, and hydraulic fluid." The company is also active in the astronautics sector, and for some years TEST-FUCHS has additionally been acting as a contract manufacturer. Robert

Schlosser, Head of Mechanical Production, adds: "The latter business segment is further subdivided into general engineering and 'on-the-fly' contract manufacturing. One of our customers in this field, for example, is Lufthansa-Technik, to whom we supply parts for the conversion of existing aircraft."

More productivity and flexibility

In recent years, customer requirements and the growth of the company have repeatedly required investments in machine tools. Following the construction of a new production hall, three existing turning machines were to be replaced. The machines taking their place were to achieve a

significant leap in productivity and increased flexibility. Robert Schlosser explains: "We work in a field of technology in which the 'µm' is the rule rather than the exception. There are only a few turning machine suppliers in this high-tech field, and INDEX is undoubtedly one of them. After all, as I see it, no other manufacturer is as consistently focused on advanced technical solutions. One example is the W-serration for the live tools, which to me makes all the difference."

One of the key main requirements for the new machines was a high degree of flexibility – since they needed to cover a very wide range of part sizes and contours. At the same time, maximum precision and surface quality had to be guaranteed.

Each machine has its own task

The TEST-FUCHS team originally focused primarily on the INDEX R-series, but as project development progressed, a real alternative emerged in the form of the INDEX G200. Robert Schlosser explains: "With the solution implemented in late

2018 – two INDEX G200 and one INDEX R200 – we found our ideal combination of machines." Each of those machines has a specific task to fulfill. As an example, the R machine is mainly used for parts requiring a relatively large number of milling operations.

The two INDEX G200 machines also have their specific uses. One of them is equipped with a flexible jointed-arm robot for part loading and unloading. This makes this machine an economical and autonomous production system for chucked parts, in particular for small production runs and repeat parts.

The other G200 is equipped with a bar loader and collet system. Both feature three turrets with 14 tools each, which represents an advantage when it comes to the TEST-FUCHS workpiece range with its individual parts and limited production runs. And with this machine concept and the wide range of available tools, the setup effort required is manageable. >



More customer success stories online:

> [index-traub.com/success](https://www.index-traub.com/success)



The programming studio INDEX VPro offers powerful and field-oriented programming support for INDEX machines, especially in combination with the "Virtual Machine" simulation software. Setup times for the INDEX G200 were considerably reduced by using this software.

Trend toward complete machining

With the new INDEX machines, those responsible for production at TEST-FUCHS can now carry out complete machining of a much larger range of parts than before. The B-axis in the INDEX G200 alone provides considerably more machining options. In addition, the INDEX G200 can handle a product range that starts at a diameter of two millimeters and is capped only by the bar clearance of 65 mm or, in the case of chucked parts, an impressive 120 mm.

The INDEX-specific 'Virtual Machine' has also proven its worth. Production Manager Schlosser: "The 'Virtual Machine' has saved us a great deal of time, especially in post processor adjustment." INDEX Sales Engineer Hermann Kraner explains: "The INDEX virtual machine enables the work program to be simulated with all data for tool use and interference contours in real time alongside the actual process, or, as here at TEST-FUCHS, even before the machine is set up. This considerably shortens the running-in phase and reliably prevents any collisions."

Further performance data of the INDEX G200

The tool drive available in the turrets provides 16 kW, a torque of 16 Nm, and rotates at up to 7,200 rpm. The rear of the upper tool carrier features a milling spindle that provides 22 kW at a torque of 52 Nm and rotates at up to 7,200 rpm. All three tool carriers can be assigned to virtually any machining task on the main or counter spindle. **X**



Top The two INDEX G200 machines handle a range of workpieces starting from a diameter of 2 mm and enabling a bar clearance of up to 65 mm or, for chucked parts, up to around 120 mm.

Bottom Three tool carriers can be used simultaneously on the INDEX G200. Each has a Y-axis and is equipped with 14 tool posts. This makes it possible to access a total of 42 tool stations and a further 6 tools from the linear magazine, all of which can be equipped with live tools.



I'm a genuine machine tool enthusiast. For that reason alone, I always want the best possible machine tools the market has to offer in our production environment.

Robert Schlosser is Head of Mechanical Production at TEST-FUCHS, seen here on the right together with Hermann Kraner, Sales Engineer at INDEX

TEST-FUCHS GmbH

Engineer Fritz Fuchs established the company Fuchs & Ledl, today's TEST-FUCHS GmbH, in 1946. Since the 1960s, the development and manufacture of test equipment for the aviation industry has been the firm's main area of business.

The group is now managed by his grandson Volker Fuchs and employs more than 600 people, some 500 of them at the main plant in Groß-Siegharts in Austria's Waldviertel region. Customers include manufacturers such as Airbus and Boeing, together with the maintenance companies of various airlines around the world.

TEST-FUCHS GmbH
Test-Fuchs Strasse 1-5, A-3812 Gross-Siegharts
» www.test-fuchs.com

info

On the right path

It has been five years now since Dr. Dirk Prust assumed the role of Managing Director of Index-Werke GmbH & Co. KG, with responsibility for two of Germany's most prestigious turning machine brand names. It seems an opportune moment to ask how much the company has changed during this time. Above all, though, to find out how the company is preparing to meet future challenges. **An interview with Helmut Angeli.**



Our slogan, *One company, two brands, one claim*, excellently sums up our philosophy. We are one company with two brands that aspire to be the best in their segment.

Inside INDEX

Helmut Angeli: *Prior to working with INDEX, you were closely associated with the German machine tool industry as Technical Managing Director of a well-known manufacturer. Back then, as an outsider, how did you see INDEX, and how has your impression of the company changed in the last five years?*

Dr. Dirk Prust: As I saw it at the time, INDEX was not just the best-known name in the field of turning, but indeed the industry benchmark. Within my environment, the INDEX and TRAUB brands were always the best choice – after all, INDEX is not only the highest-grossing European manufacturer of turning machines; it also enjoys an excellent reputation for productivity and product quality throughout the metalworking industry.

Today, of course, I have a slightly more nuanced opinion. My personal impression has not changed since then, but I've learned that there is much more to turning from a technical perspective – from the high number of simultaneous tool systems on the one hand, to the wide range of machining technologies on the other. Our equipment is mostly used to machine high-precision, complex workpieces that frequently require processes that go far beyond turning and milling. In this respect, I see our company in a very good position.

What kinds of standards and ideas did you bring to your new management role?

My main concern was to improve efficiency. In terms of products, this primarily involved developing a modular system to significantly reduce the number of variants without diluting the product range. This made it possible to restructure production at our three German locations, combined with organizational changes and the reorganization of flow manufacturing, including logistics processes. The result: we can respond to customer requirements very quickly without having to maintain excessively large stock levels.

Does this fully describe your goals in 2015?

We have also worked to expand our international reach and prepared ourselves to exploit the potential of digitization.

What exactly do you mean by digitization – “Industry 4.0”?

Not at first. Initially, these were mainly internal projects to improve productivity. One example was the introduction of an internationally standardized ERP system, which, as the mainstay of

our cloud platform, additionally allows us to handle business processes with our customers. In other words, we make full use of all the relevant data here.

INDEX invested a great deal of its development resources in the topic of “Industry 4.0” earlier than most companies in the industry. Has its commitment really paid off?

A resounding yes. Digitization is the basis for “Industry 4.0” and thus a clear focus of our strategy. We approached this task step by step and quite deliberately started out by focusing not on real-time apps, big data, AI, and so on, but rather on connectivity, data security, and a robust platform – infrastructure, in other words. As a result, we now have a reliably functioning system ...

... that wasn't created to meet customer needs, though, but was instead pushed by providers...

... I wouldn't fundamentally disagree with that. Supply comes before actual demand when it comes to the majority of developments relating to “Industry 4.0”. That needn't be wrong in itself. Take the example of a touch display. No user requested that actions be carried out by swiping with a finger. But supply created genuine demand. We can expect similar things from “Industry 4.0”, as ultimately the customer is given access to a wide range of useful and valuable information.

The question is, how do you get customers to know what's available?

With every machine we deliver, we give our customers the opportunity to use our iXworld IoT platform for 12 months, without restriction and without charge. We've seen that most users are then happy to start paying for the service – for a very moderate fee considering the benefits it brings.

And what are the benefits to the customer of the “iXworld” platform?

This cloud-based platform gives customers access to our iX4.0, iXshop, and iXservices portals. iX4.0 makes valuable data available ‘live’ for usage analyses – i.e. to optimize in-house processes – and the machine's condition data. Compatible spare parts or even toolings can be ordered directly in iXshop with the correct pricing conditions. We offer support and optimization in using the machine with iXservices. We took great care to make usage as simple and clear as possible and are continuously adding to the available functions. >



With our “Strategy 2020”, we have been pursuing a highly dynamic and successful corporate development program since 2015 that affects every single aspect of the company. Our people have achieved outstanding results and developed a strong team spirit.

Despite all the similarities between INDEX and TRAUB, are there also clear differences between the two, for example in terms of controllers or customer groups? Does it really make sense to bring the two companies even closer together?

Our slogan, ‘One company, two brands, one claim’, excellently sums up our philosophy. We are one company with two brands that aspire to be the best in their segment.

Is the “two-brand principle” with the modular approach you mentioned compatible with the brand concept at all, or will the machines become interchangeable?

There are virtually no real product overlaps. Even if some machines will use the same mechanical basis in the future, the two systems will differ fundamentally, if only because of the respective CNC controllers. For some, the Mitsubishi controller with the TRAUB interface is the ultimate in control technology, while others feel in good hands with Siemens control systems. In other words, customers are dealing with two different machine tools in terms of their look and feel.

With many assemblies and components, we’ve also adopted the principle of “the best of both worlds” by selecting the best from two established products. In addition, we have adopted proven concepts to expand our product portfolio.

An example is the INDEX B400 and B500 universal series. It is based on specific TRAUB expertise and would not exist if we were unable to draw on it.

There are barely any INDEX machines that can be operated without well-trained employees. Do they even exist in your foreign markets?

Firstly, we support the operators with intelligent, in-house software components that make setting up the machine much easier wherever possible. And in any case, it is a fallacy to assume that low-cost machines are mainly used in those markets. We see this clearly in China, which is clearly moving up to a technology level comparable with ours. This is based on the realization that internationally required quality standards cannot be achieved with simple machine concepts. And last but not least, we assist our customers in solving even highly complex tasks with training courses.

INDEX has never had a leading share of customers from the automotive industry; nevertheless, the company will not be completely unaffected by the growth of electromobility ...

... I wouldn’t say completely unaffected, considering our automotive share of around 50 percent. But there are a large number of reputable >



Dr. Dirk Prust

has been Technical Managing Director of the INDEX Group since 2015. As the Spokesperson for the Executive Board, Dr. Prust heads INDEX-Werke GmbH & Co. KG together with Sales Director Reiner Hammer and Commercial Director Harald Klaiber.

Prior to this, he worked for the Chiron Group for 17 years, 12 of which he spent as Managing Director, most recently with responsibility for the Sales, Technology, and Service divisions.

Helmut Angeli

is a freelance journalist. After completing technical training as a toolmaker, he studied communication and political science. Following many years as editor-in-chief of various trade journals published by “Moderne Industrie,” he was most recently editor-in-chief of the journal “NC-Fertigung”

Top The introduction of flow manufacturing in the assembly environment enables us to react very quickly to customer-specific requirements without having to maintain excessively large stock levels.

studies that put the pace at which purely electric vehicles will populate the market into perspective. Irrespective of all forecasts and other considerations, we must of course prepare ourselves for reduced demand from the automotive industry. We will compensate for this, primarily by expanding our product range in order to offer attractive solutions in other segments. This concerns larger machines, for example for industries such as energy, agriculture & mining, aerospace, offshore, and also smaller centers for medical technology.

The corona pandemic has had an enormous effect on day-to-day business operations. What kinds of solution can help or have helped to mitigate these problems?

Compared to other economic crises in the past, the corona crisis is having a very profound effect. Never before have practically all industries around the world been put on hold at the same time. For manufacturers of machine tools, this will also result in a presently unquantifiable slump in demand.

The crucial issue for the entire industry is when demand will pick up again. Right now, there is little to suggest that we will see a steep rise comparable to that of 2009/2010, although there are signs that inquiries, at the very least, are slowly recovering.

So far, we have countered the crisis with the familiar instruments of short-time work, a stop on temporary work, the reduction of overtime, and the expiry of fixed-term employment contracts. We need to match our capacity to future demand.

We really shouldn’t end this interview with such an uncertain outlook. Is there something positive we can end on?

INDEX is coming out of a boom period; 2019 saw a new record in revenue of over 600 million euros and at the beginning of the year we had a very good order backlog.

INDEX will still be around long after the crisis has passed. The company is in a good position, we have an excellent, dedicated workforce, a great deal of expertise, and a first-rate product range. All things to inspire confidence that we will be able to increase our market share, even after the corona crisis. X

Prepared for the future with iX4.0

A company can only be successful in the long run if it works continually on improving its productivity. As a company with a high level of vertical integration, this is a challenge we face every day. We use high-quality machines and tools to manufacture our machine components, fully convinced that there is no future for production in high-wage regions without state-of-the-art automation and digitization solutions.

Based on this insight, we developed the iX4.0 IoT platform as the fundamental component of our digital iXworld.

The iX4.0 effect

The IoT platform assists you in

- ▶ increasing production uptime
- ▶ reducing unscheduled downtime
- ▶ ensuring the traceability of batches

Try it out with no obligation – accompanied by our iX4.0 specialists

We will be happy to show you how you can continually improve productivity with iX4.0. When you buy a new machine, you have the chance to try "iX4.0 go" for 12 months free of charge – including all available apps and support from our iXworld specialists.

If you're happy with the benefits it brings to your company, you can keep on using it after the first year for a moderate monthly charge. You can also pick specific optional apps to add to your subscription.

What can the iX4.0 cloud platform do?

With iX4.0, you can quickly and easily connect machines that are located at different production sites. Machine data can be viewed in real time. Data analysis is performed continuously in order to detect problems and therefore avoid machine downtimes. Built exclusively on SAP technology, iXworld with the iX4.0 IoT platform employs the highest security standards. The data connection, for example, even now meets the requirements issued by the German Federal Office for Information Security. Certification pursuant to IEC 62443 is due in the near future.

Helpful transparency

Production managers, in particular, will benefit from numerous features. The visualization of machine states on a PC or tablet inform them of what is happening on the shop floor.

Utilization and output figures for each machine are typically required for status reports and shop floor discussions. No problem: the Equipment-Manager presents the data from all connected machines in one clear display. ▶

iX4.0 apps: transparency for more efficient production



Further support is provided by the MDA/ODA app, which ensures even greater transparency in the production environment. It can be used, for example, to analyze the causes of any productivity losses and prevent unscheduled downtimes.

Prevention and analysis for reliable production

If a machine is displaying nonconformities, it is usually time for the maintenance engineer to get involved. He or she consults the StatusAnalyzer in the iX4.0 software, which displays active alarm messages, if requested filtered by downtimes and sorted by frequency of occurrence. This makes it easy to quickly isolate causes and substantiate them with further apps. In conjunction with iXshop, it is also easy to order the required spare parts.

If troubleshooting as described remains unsuccessful, the maintenance engineer contacts the INDEX service hotline using the TicketManager.

The generated service ticket is directly forwarded to the hotline group responsible for the affected machine type – a diagnostics specialist then reports back. If required, the teleservice and video call are available – both elements of the iX4.0 basic package designed to make fault diagnostics as efficient as possible and restore the availability of INDEX machines in the shortest possible time. X

Get connected to the digital world with "iX4.0 go":

▶ www.index-traub.com/ix40

AWA goes iXshopping: Easy, fast, and secure orders

Armaturenwerk Altenburg (AWA) has been using the iXshop procurement portal from INDEX, an essential component of the digital iXworld, for almost two years. It has been a very positive experience for AWA maintenance. In particular, ordering spare parts has become easier, faster, and more secure with iXshop.

High level of vertical integration

Based in Altenburg in Thuringia, Armaturenwerk AWA supplies a wide range of components for refrigeration and air conditioning technology. A distinguishing feature of its business is the high level of vertical integration, made possible by a cutting-edge machine fleet with powerful CNC machining centers and CNC turn-mill centers. The aim: maximum quality and reliability.

Premium-quality turned parts

In the field of CNC lathe technology, AWA almost exclusively uses INDEX machines. The production hall is therefore home to several INDEX MS32 and MS52 multi-spindle automatic lathes, together with G200 and G300 turn-mill centers and C and ABC-series production turning machines. The facility houses a total of 20 INDEX machines. Machine maintenance is the responsibility of Thomas Winter and one of his colleagues. He explains: "We demand a lot from our INDEX machines. After all, we use them to produce a wide range of components, from valves, spindles, flanges, and nuts, to housings made of square bar stock – primarily in 3-shift operation." He confirms that INDEX machines are without

exception extremely robust and precise. As he adds, however, this heavy use requires regular maintenance to ensure trouble-free operation without long downtimes, including rapid replacement of required wear parts.

Ordered today – delivered tomorrow

Thomas Winter was thrilled when INDEX first presented the digital iXworld at its Open House 2018. He convinced the company's management of the benefits of iXshop and was ordering his first spare parts as early as November 2018. "After trying it out twice, it was an immediate success. And it's extremely user-friendly. If you order through iXshop, INDEX delivers the very next day." In the last two years, AWA has ordered around 150 spare parts in this way, equating to over 60 percent of its total orders. And this figure is rising, because Winter still needed support from INDEX service for some parts in the past.

The functions and options available on the entire platform are constantly being expanded and improved in order to offer customers the greatest benefit: fast and easy orders. **X**



The launch of the digital INDEX iXshop was a milestone moment for us. It enables quick and reliable part identification and has made us much more flexible when it comes to ordering spare parts. We were able to significantly minimize the time required for ordering and time to delivery. I personally enjoy working with the iXshop!

Thomas Winter is Head of Maintenance at Armaturenwerke Altenburg



More customer success stories online:

[index-traub.com/success](https://www.index-traub.com/success)

Top AWA focuses on quality: valves, spindles, flanges, and nuts are produced on over 20 INDEX automatic lathes. Even housings made of square bar stock are manufactured on turn-mill centers.

Center Whether it is multi-spindle or single-spindle machines – sophisticated machine technology requires careful maintenance and service.

Bottom Steel housing for Rotalock valves entering the brazing furnace

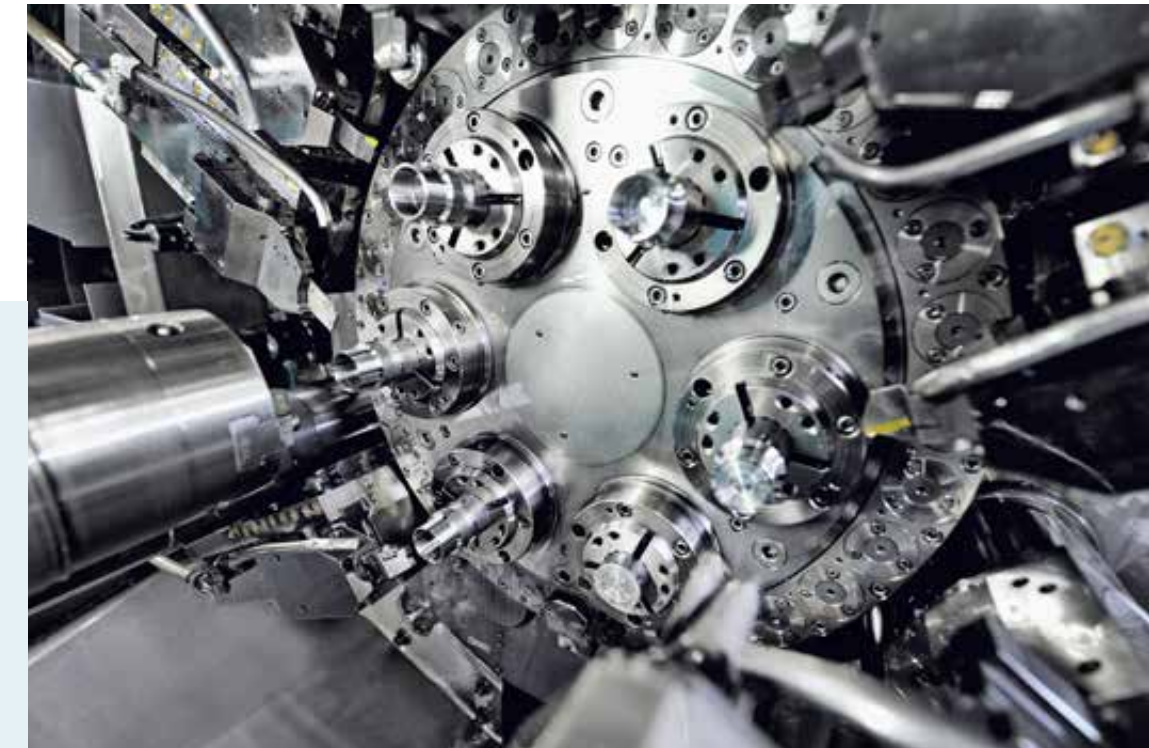

Armaturenwerk Altenburg GmbH

Armaturenwerk Altenburg (AWA) is one of Europe's leading manufacturers of valves, sight glasses, fittings, adapters, and other components for refrigeration and air conditioning technology. The Thuringian company was founded in 1879 and has been part of the BITZER Group since 2013.

All manufacturing takes place at its headquarters in Altenburg, where around 200 employees work in development, production, and administration.

Armaturenwerk Altenburg GmbH
Am Weißen Berg 30, D-04600 Altenburg
www.awa-armaturenwerk.de

iXshop

- ▶ Currently over 130,000 quality items
- ▶ Orders placed by 3:30 pm are usually sent out the same day
- ▶ Find what you need quickly with intelligent search functions
- ▶ All information at a glance
- ▶ Procurement processes to match your needs
- ▶ Straightforward returns processing

Register free now to enjoy the benefits:
ixshop.index-traub.com



The TRAUB TNL12 – reimagined!

The TRAUB TNL12 sliding headstock automatic lathe with 13 mm spindle clearance has represented premium performance in its class for many years. Where its predecessor model set standards, the second, newly developed generation of the TNL12 reinforces its claim as a pioneer – with increased productivity and flexibility, reduced space requirements, and much more.

Easy changeover to the new generation: Further increasing the benefit to the customer was the top priority during development of the new TRAUB TNL12 sliding headstock automatic lathe. We therefore made it easy for users to switch from the former TNL12 machine. They can continue to use existing tool holders for the turret and the front and back working attachments, as well as supplement them with new, more powerful models. The working area has been designed in such a way that all workpieces produced on a first-generation TRAUB TNL12 can continue to be produced on the new model.

Compact design: The control cabinet on the new TRAUB TNL12 is no longer located underneath the bar loader but is now fully integrated within the machine. This means that the TNL12 now stands 1,600 mm tall, but is still “manageable”. The benefits of integration: less work during initial installation, less need for adjustment with the bar loader, fewer cable ducts, and simplified machine relocation – on armored casters, via forklift, or with a crane.

Improved kinematics: Where the front working attachment and counter spindle were previously arranged on a common slide, they are now on separate slides and can therefore be programmed separately as well. Front-end and counter spindle machining also no longer influence each other. With lower masses, the machine is more dynamic, and users benefit from greater programming freedom.

Upgraded rear-end machining: Whereas only one movement in the X direction was previously available on the rear end, three-axis machining on the counter spindle is now possible. The new back working attachment comprises six tool stations (4x live, 3x with internal cooling), including a flushing unit.

Larger tool pool: With double and triple holders, a total of up to 40 tools can be set up in the machine, opening up additional possibilities for complex machining operations. In addition, the two tool turrets (six stations each) are provided with a servomotor and an interpolated Y-axis, >



In a nutshell:

Our new, small TRAUB TNL12 sliding headstock automatic lathe can easily be converted to a fixed headstock, just like its larger cousins.

Daniel Baumann is Project Manager in Development and Design of the TRAUB TNL12 at INDEX



Efficient production of both simple and complex parts

Due to its outstanding performance and flexibility, the TRAUB TNL12 is predestined for various sectors such as the medical technology sector, where it is used for the production of implants, devices for minimally invasive surgery, and even bone screws. It can of course also be used to manufacture simple workpieces. The range of available options includes a whirling unit with a $\pm 30^\circ$ swivel angle that is suitable for high-speed whirling and offers a whirling length of 75 mm.

The advantages of the TNL12 can of course also be used for workpieces in other sectors, such as electrical engineering, the automotive industry, or precision engineering.



which contributes to shorter chip-to-chip times of only 0.3 s and a freer division of cuts.

Improved dynamics: This is ensured by fluid-cooled motor spindles with rotational speeds of up to 12,000 rpm, which replace the belt drive in the main and counter spindles. Details such as low-mass clamping cylinders and a carbon sleeve for the drive of the (freely selectable) guide bushing also make the new TRAUB TNL12 more dynamic.

For the tools in both the turrets and the front and rear working attachments, gear trains have been minimized and only the active tool is connected to the drive. This ensures quiet operation and minimal heating.

Increased precision: The non-hydraulic design, a gray cast iron bed instead of the previous welded steel construction, and the thermo-symmetrical design ensure increased thermal accuracy combined with reduced pause jumps and shorter warm-up times. As short a power flow as possible increases the stability of the machine and thus leads to improved overall accuracy as well as higher cutting values, which in turn benefits the machining times.

Ideal cooling lubricant management: Up to three pumps are available: one 8 bar pump as



standard, to which one or two adjustable 20 – 120 bar pumps can be added. The cooling lubricant is cleaned by a compact belt filter with a filter fineness of 50 μm . Coolant cooling is also available. Users can choose between a chip tray or a chip conveyor for chip disposal.

Three options for automated operation:

These include rinsing (minimal setup), a small gripper that can deposit the components in a tray or on a small conveyor belt, or removal through the counter spindle – relevant for long parts. All the elements are also in place for a robot solution, which will then be responsible for feeding chucked parts. **X**

Expansion options from the modular system for high productivity and flexibility.

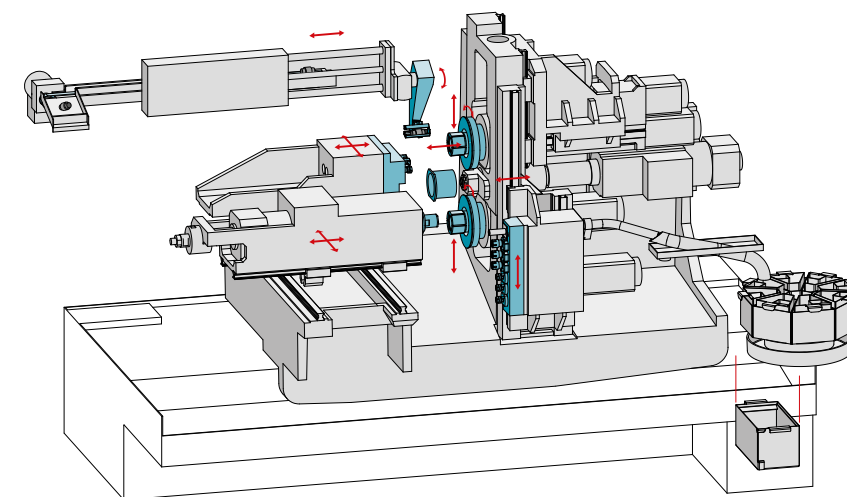

TRAUB TNL12 machine highlights

- ▶ Bar clearance up to $\varnothing 13$ mm
- ▶ Up to four tool carriers for simultaneous tool use
- ▶ Large tool pool for setup-friendly production
- ▶ Brief tool change times thanks to CNC indexing axis in the tool turrets, front working attachment and back working attachment
- ▶ Easy changeover from sliding to fixed headstock operation
- ▶ Extremely compact machine layout for high productivity per unit area
- ▶ Engineering excellence "Made in Germany"



Watch the film now:
▶ index-traub.com/tnl12-video

info

Medical solutions: economical and highly precise

Surgically precise and safe processes are essential in medical applications. The high-precision and dynamic automatic lathes and turn-mill centers from INDEX and TRAUB are optimally designed for the manufacture of complex implants, prostheses, instruments, and other devices. Solutions that are individually matched to customer requirements ensure top performance.

Your product idea is our challenge. Decades of experience across the full range of the medical sector empower us to assist you in finding the best solution for your requirements. No matter which material, production strategy, or quality requirements apply – with high-precision and dynamic automatic lathes and turn-mill centers from INDEX and TRAUB, you can be sure you've made the right choice. The machines are ideal for manufacturing complex implants, prostheses, instruments, and other devices.





Our specialists will be happy to demonstrate with turning tests and test machining. Clamping device and tool tests are also among the recurring daily tasks performed at our "INDEX Medical Technology Center". In this way, we work to develop the best process and machining strategies – without losing sight of unit costs, tolerances, and an ideal surface quality. This ensures reliability and saves both time and cost. We also support

you in the validation of your production processes in accordance with the requirements and quality standards in force around the world. **X**

Technology expertise – in the right place





For decades, the INDEX Group has been working with a wide range of technologies, such as polygon turning, gear cutting, high-speed whirling, deep-hole drilling, grinding, marking, deburring, engraving, and measuring. The technological diversity that can be deployed on INDEX and TRAUB machines is almost inexhaustible. It opens up far-reaching possibilities in the world of medical technology. Contact us if you are looking for high-precision and economical, application-specific manufacturing solutions.

Monoaxial pedicle screw

-  TiAl6V4
-  8 x 70 mm
-  490 seconds
-  TRAUB TNL20-9B
[Sliding headstock
automatic lathe]



Tulip-head locking screw

-  TiAl6V4
-  5 x 10 mm
-  114 seconds
-  TRAUB TNL20-9B
[Sliding headstock
automatic lathe]

INDEX specialists with extensive expertise in medical technology and many years of experience develop application-specific solutions together with customers at the in-house "INDEX Medical Technology Center".



Reliable processes carried out under clean room conditions are essential in the production of sophisticated medical instruments at A.M.I.
Photo: TM-Hechenberger, Bludenz

Innovative medical technology in the clean room

A.M.I. GmbH is a key partner to the surgical community throughout Europe when it comes to medical devices and solutions, especially for minimally invasive surgery. The Austrian company manufactures the mechanical components with the necessary precision and surface quality. Two TRAUB sliding/fixed headstock automatic lathes are of central importance in this respect. **By Robert Fraunberger // "Fertigungstechnik" magazine**

Innovations for surgeons, from surgeons – this has been the recipe for success at A.M.I. Agency for Medical Innovations GmbH for 20 years. In Feldkirch (Vorarlberg), around 95 employees evaluate product ideas for medical devices and develop them to market maturity. The company specializes in surgical fields relating to the pelvic floor – laparoscopy, coloproctology, urology, gynecology, obesity, and infusion systems.

Customers are mainly specialist hospital departments. Florian Kröll, who has been responsible for production at A.M.I. for around two years: "Our goal is to improve the quality of surgical patient care by developing innovative products and methods. In the process, we are supported and assisted by a group of medical experts."

High level of vertical integration for top quality

A.M.I. has been steadily growing for many years. "With our broad product range and stringent quality standards, in-house production is of great importance," says Kröll. Today, the company premises in Feldkirch comprise three groups of buildings, including three clean rooms and an air

conditioned mechanical production facility. "Our products are manufactured to the strictest quality standards in accordance with European guidelines for medical products. All of them bear the CE mark and are approved for sale worldwide."

A.M.I. currently manufactures the mechanical components required for the devices and surgical instruments on ten modern CNC machines. "Thanks to our high level of vertical integration, we can ideally support the product development process and give direct feedback. We also possess expertise in machining chrome steel and titanium. We can guarantee the necessary precision and surface quality, even for the smallest and most complex components," says Florian Kröll with pride. The components include forceps, tie rods, tiny screws or rivets, jaw parts, nails, or tubes of up to 50 mm in length and made of 1.4301, 1.4021, titanium, aluminum, or plastic. Demand ranges from 2,000 to 6,000 units a year.

Productive and precise

When it comes to turning operations, the majority of the complex components are manufactured from bar stock on the TRAUB TNL18 or TNL20 >



The two TRAUB TNL automatic lathes offer great ease of use and high precision in the machining processes together with maximum dynamic response. Once a component has been inserted, it can be produced extremely quickly and thus extremely economically.

Florian Kröll is responsible for production at A.M.I.



A.M.I. uses the TRAUB TNL18 and TNL20 sliding/fixed headstock automatic lathes to machine these complex and mostly very small medical technology parts.

sliding/fixed headstock automatic lathes. The company has been using the TNL18 in two-shift operation since 2012: "Both its impressive performance and the accuracy achievable for a wide range of components are remarkable. Even the smallest parts can be removed through the counter spindle." Due to further increase in demand in recent years, A.M.I. also commissioned a TRAUB TNL20 in 2019.

Economic production

According to Florian Kröll, one of the reasons why the company decided to use TRAUB is its high-quality engineering, which offers maximum productivity with the greatest possible precision. "When I took over the production management

two years ago, the complex subject of sliding headstock turning was relatively new to me. With their ease of use and precision, combined with maximum dynamic response, the two automatic lathes are now my absolute favorite machines. Once a component has been inserted, the two TRAUBs allow for extremely fast and thus extremely economic production."

Even with the smallest components, such as rivet heads, the TRAUB TNL20 consistently maintains the required level of precision: "This is often less than a hundredth of a millimeter, with a surface quality smaller than $Ra = 0.2 \text{ mm}$," says Florian Kröll. After machining, the components are freed from any residues such as machining

Left The clearly structured exterior of the TRAUB TNL20 is based on the technical requirements – without unnecessary breaks and edges. A large inspection window to the work area, as well as a roller shutter that allows for convenient access to the main spindle and its peripherals ensure outstanding ergonomics.



Right Even with the smallest components, the TRAUB TNL20 consistently maintains the required level of precision and surface quality.



oil etc. by means of ultrasonic cleaning. This is followed by a 100% quality control procedure, whereby each part must also be traceable via its batch number.

High level of flexibility

As a clear advantage, the production manager emphasizes the possibility of machining components flexibly on both machines, since tools, controllers, and machining programs are all identical. "We largely program using the TRAUB dialog controller, thanks to its great ease of use."

Also in use at A.M.I. is the TRAUB WinFlex IP-SPlus software for programming, simulation, and optimization. It allows simulations to be carried out on a PC prior to real-world use. This optimizes the set-up and programming process and ensures considerably shorter setup times, increased process reliability, and improved machine utilization.

Florian Kröll is also very happy with the excellent service and support on offer: "Issues can often be quickly resolved by calling the programming hotline, where proven experts are on hand to assist. If necessary, they can directly access our machines to ensure they provide optimum support." X



At A.M.I., most of the programming is carried out on the TRAUB TX8i-s V8 dialog controller: The control panel featuring a 19" multi-touchscreen offers outstanding ease of use, especially with the touch user interface, expanded to include gesture control. Intuitive gestures such as tapping, dragging, moving, swiping, zooming, or rotating are possible, similar to a smartphone or tablet.



Watch the film here:
www.zerspanungstechnik.at/detail/traub-tnl20-9b---knochen-schraube_163422

A.M.I. Agency for Medical Innovations GmbH

A.M.I. is a manufacturer of innovative medical equipment based in Feldkirch, Austria, from where it develops, produces, and markets its products.

All of its products enable minimally invasive procedures and better surgical results, thus reducing pain and accelerating the healing process.

A.M.I. employs 95 people at its headquarters, and 130 worldwide. 80% percent of its primary markets are located in Europe.

A.M.I. GmbH
 Im Letten 1, A-6800 Feldkirch
www.ami.at

info

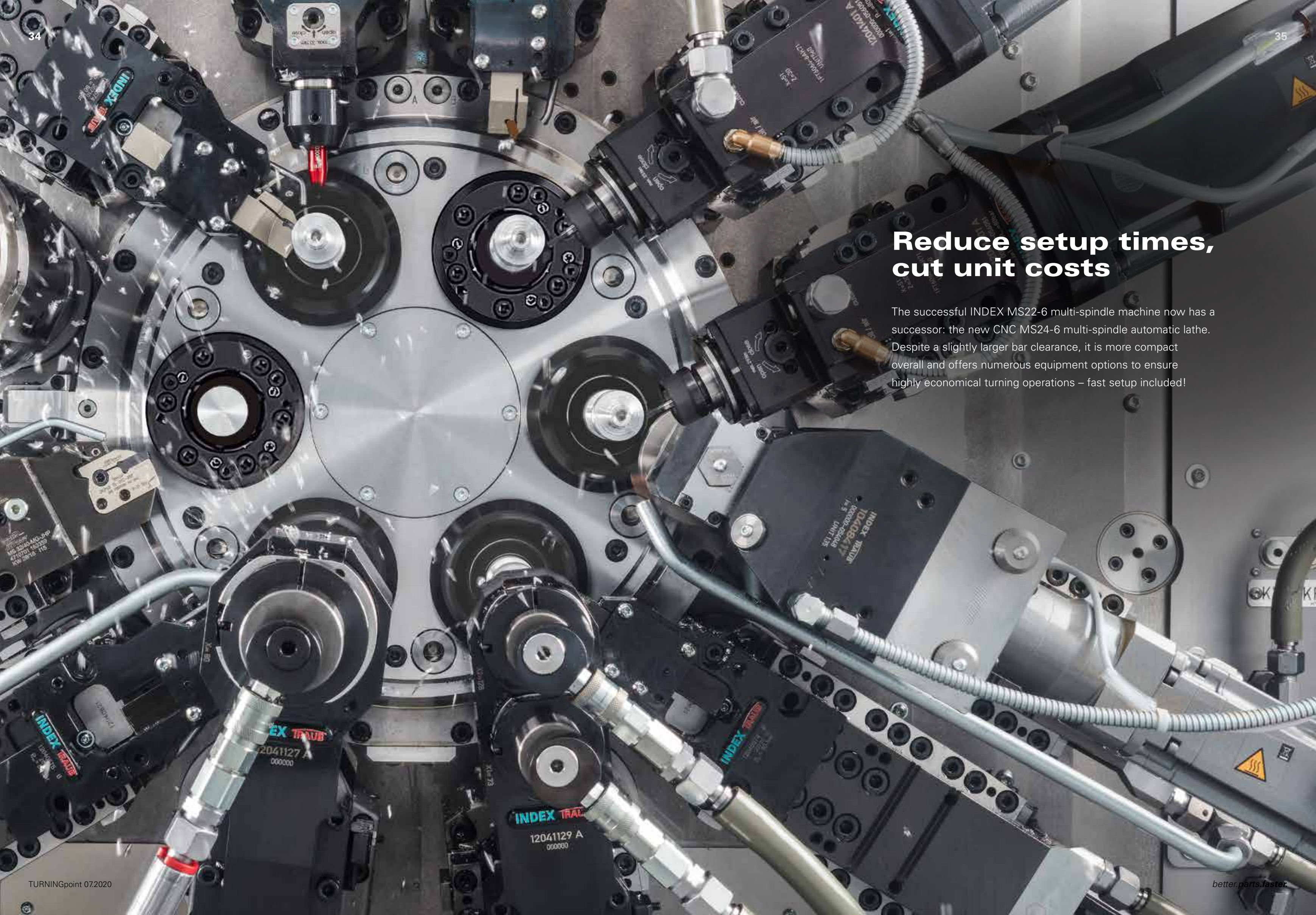

Reduce setup times, cut unit costs

The successful INDEX MS22-6 multi-spindle machine now has a successor: the new CNC MS24-6 multi-spindle automatic lathe. Despite a slightly larger bar clearance, it is more compact overall and offers numerous equipment options to ensure highly economical turning operations – fast setup included!

INDEX MS24-6 CNC multi-spindle automatic lathe

Whereas multi-spindle automatic lathes used to produce many millions of parts throughout the year without having to be retooled, it is now not uncommon for contract lathe operators to have to retool their multi-spindle machines several times a week. An optimized concept, such as the one offered by the new INDEX MS24-6 multi-spindle automatic lathe, is essential for economical setup.

INDEX quick clamping system

One special feature is the INDEX quick clamping system with integrated W-serration on the cross slide. Instead of the previously common dovetail system, each cross slide now features a W-serration to greatly simplify micrometer-precise alignment of the tool holder: simply attach the preset tool holder, fix it in position with the new quick clamping system, a quick turn with the wrench – and you're done! "This reduces the time needed to change the tool holder by up to 50 percent compared to conventional systems. Errors are a virtual impossibility," says Karl-Heinz Schumacher, Head of Development and Design of Multi-Spindle Automatic Lathes at INDEX. There are matching turning tool, drill, and double drill holders for the slides with W-serration, as well as live units for milling, polygon turning, and

drilling. The tool holders of the MS22-6 can, however, also continue to be used.

Broad range

Designed using a flexible modular principle, the new INDEX MS24-6 multi-spindle automatic lathe is most impressive in demanding machining tasks. The machine features six work spindles and twelve cross slides with NC axes in X, Z, and Y (4x), as well as one or two synchronous spindles for rear-end machining. This means that the machine can be used either with six spindles or two times three spindles. Double rear-end machining is also possible. Live tools, a C-axis, and a Y-axis provide users with a broad range of machining options such as off-center drilling, threading, contouring, and hobbing, or polygonal turning.

One key component of the INDEX MS24-6 is the unique, fluid-cooled spindle drum (15 kW at 25% DC per spindle, max. 10,000 rpm) with its optimized thermal growth and pause jump behavior. In addition to the existing clamping options, Axfix TOPlus24 is now also available as a clamping device that uses the principle of compression clamping, which prevents axial displacement and achieves maximum concentricity – a system >

One of the strengths of our new CNC MS24-6 is undoubtedly its fast and simple setup, which generates clear unit cost advantages with decreasing batch sizes.

Karl-Heinz Schumacher is Head of Development and Design of Multi-Spindle Automatic Lathes at INDEX

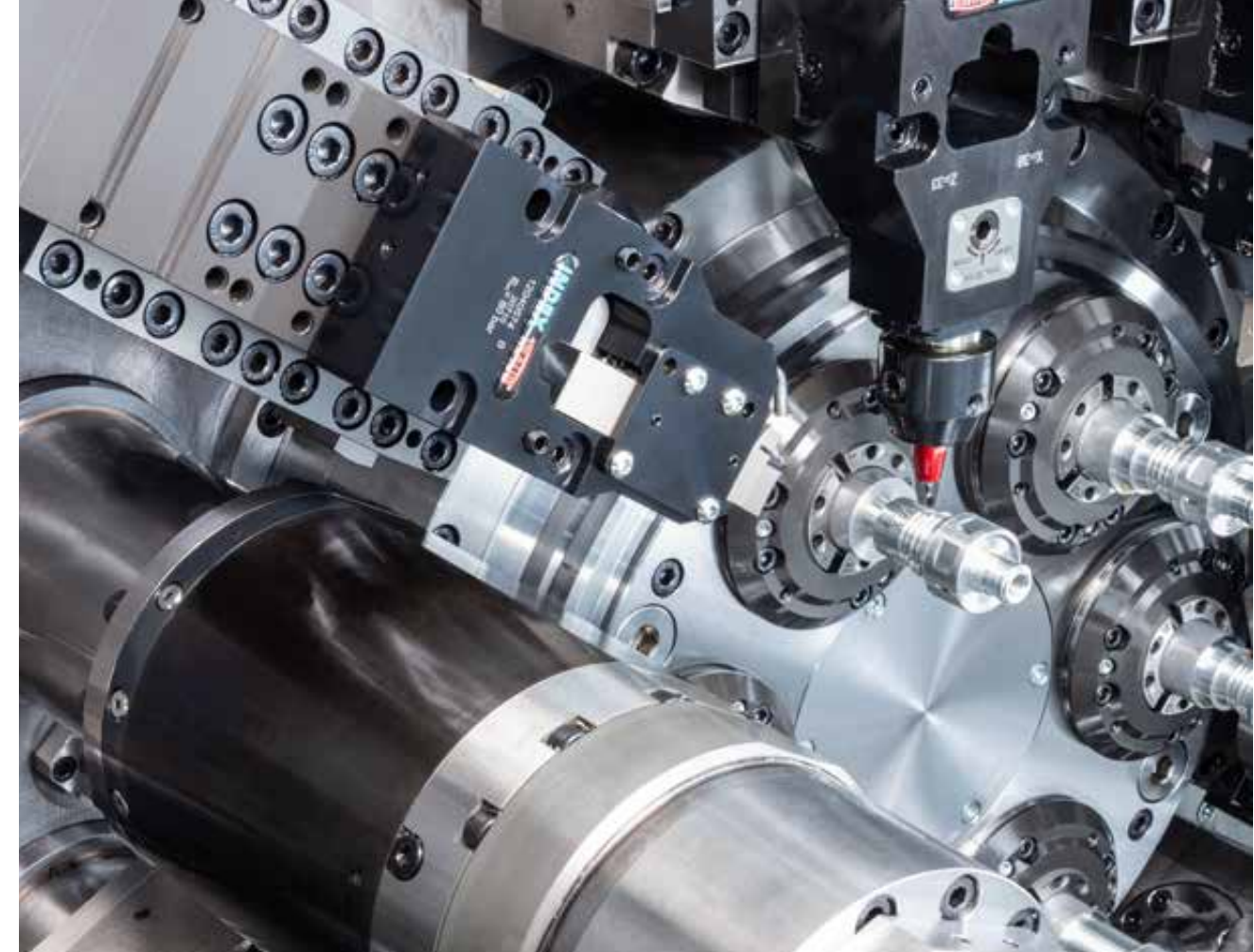

Like the other models in the current INDEX multi-spindle series, the MS24-6 boasts an attractive design with premium equipment features: Fluid cooling of the spindle drum, counter spindle, and control cabinet ensure ideal thermal stability. The INDEX MS24-6 also features unique warm-up performance. The machine adjusts to a constant temperature within a very short time.

particularly recommended for high-precision, pre-machined semi-finished parts that are inserted by a robot.

Flexible automation solutions

In addition to robot automation, which is predestined for the machining of demanding chucked parts, new orderly part removal solutions are also available for bar machining: with an additional swivel unit that takes the cut part from the synchronous spindle and places it in the correct position on the conveyor belt, or with an intermediate gripper, to which the synchronous spindle transfers the cut part in a first handshake. A linear unit removes the part from the intermediate gripper and moves it out during the machining process. The time for full part handling is less than 5 seconds! X



Thanks to the INDEX quick clamping system with integrated W-serration, tool holders can be changed in almost no time and without any complex alignment work.

INDEX MS24-6 machine highlights

- ▶ Flexible modular concept
- ▶ Reduced footprint due to optimized coolant system
- ▶ High repeat accuracy thanks to INDEX quick clamping system
- ▶ W-serration for reduction in setup time
- ▶ Minimized thermal growth with fluid-cooled spindle drum
- ▶ Both tension and compression clamping on the main spindle
- ▶ Various automation solutions for parts infeed and removal
- ▶ Engineering excellence "Made in Germany"



Watch the film now:
 > [index-traub.com/
ms24-6-video](https://index-traub.com/ms24-6-video)

info

iXservices – for a long, efficient machine service life

Owning an INDEX or TRAUB machine means owning a unique quality product. We offer an extensive range of services to ensure that your production remains fault-free and efficient, now and in the future.

Everything we do revolves around your productivity

With over 150 service engineers in Germany and service centers in over 50 countries around the world, we are fully committed to taking care of your machines and other needs. When a fault or damage occurs on a machine, a quick response is required. In over 50% of all cases, faults can be rectified directly via our service hotline. The digital "TicketManager" with innovative remote support is also very efficient. And for tasks that require on-site attendance, we will of course

continue to make our way to you as quickly as possible.

Our wide range of maintenance services helps you to increase the availability of your machines. We offer process support for your operating business so that you can manufacture even more productively. And, finally, our experienced training team ensures that your employees use their INDEX and TRAUB machines in the best possible way. >



Whether you need a machine check, attractive maintenance contract, retooling, or training – we're here and ready to help.

Now's the right time ... Proactively prevent downtime!

Your direct contact with the INDEX service team:

- > service@index-werke.de
- > Phone +49 (0) 711 3191 - 600

NEW: INDEX service hotline now with TicketManager:

- > www.index-traub.com/ticketmanager



Greater availability

The basis for reliable technical availability is a condition analysis with the INDEX machine check. For attractive fixed prices, we inspect your machine to enable targeted maintenance, overhaul, and repairs.

Use the wide range of INDEX maintenance services to avoid downtimes. They offer you planning reliability with a range of services tailored to your needs.

If your machine is slowly becoming outdated, that is no reason to think that productive work is no longer possible. Through the INDEX refit service, we carry out repairs, the professional overhaul of spindles, guides, and other valuable components, as well as the complete refit of your machine – with OEM quality. As a result, we maintain the value, reliability, and productivity of your machine.



Increase productivity

Whether you are setting up or retooling – take advantage of our expertise. We promise to quickly set up or retool your machine to match your process and minimize downtimes.

We also offer you process optimization of your current production. Our experts optimize your production process on the basis of a targeted analysis – all the way to retrofitting your machine or digitizing your production environment.



Professional qualification

Our training team offers a wide range of training courses. Your machines will be even more productive if they are operated by well-trained personnel. We pass on our comprehensive expertise of your INDEX and TRAUB machines at our modern training centers or at your site. X

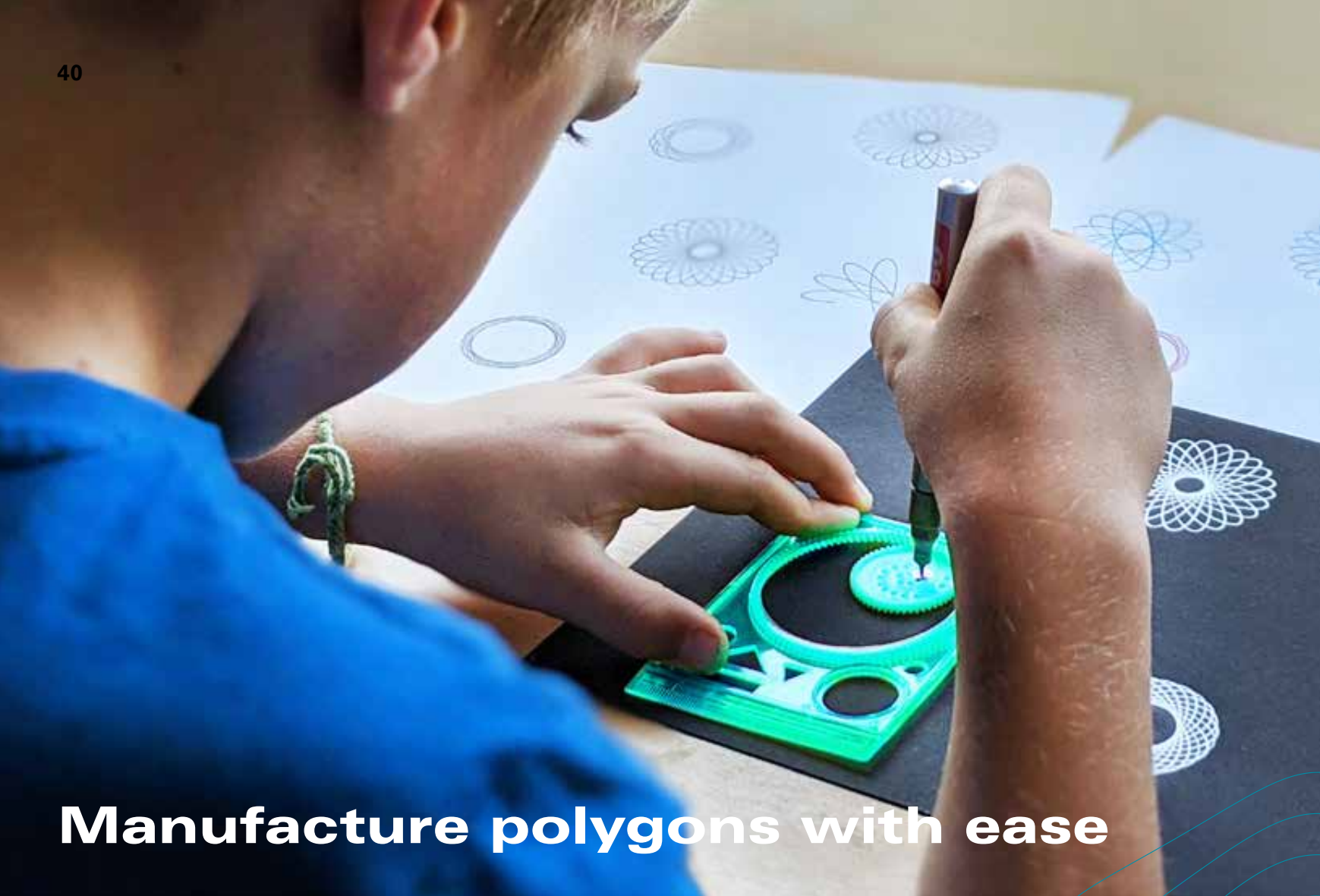

Manufacture polygons with ease



Polygons are extremely reliable and very durable, especially for shaft/hub connections. With the INDEX polygon turning cycle, we have created a tool that allows us to provide our customers with excellent support.

Dr. Volker Sellmeier is Head of Technology Development at INDEX



Polygonal shaft/hub connections have many advantages, but producing these cross-sections has always been a highly demanding and fairly unproductive process. Polygon turning changes this. With this innovative process, polygons with widely differing numbers of vertices and various shapes can be turned easily, highly productively and extremely precisely, without the need for complex special fixtures. **Volker Sellmeier** explains how it works.

Conventional shaft/hub connections such as parallel key systems, splines, or splined shafts, have a number of design and manufacturing drawbacks. Due to their design, they tend to form cracks and imbalances. In terms of manufacturing, they often require special machines and processes, and, when it comes to splines, even special measuring devices. By contrast, polygonal shaft/hub connections feature a continuous form without sharp edges and are therefore not prone to cracking. They allow very high torques to be transmitted. And they are self-centering. One of the best-known shapes is the P3G profile standardized in DIN 32711. For a long time, one disadvantage of polygon profiles has been the complex

programming and production required by coordinate milling and grinding. The tools had to be sufficiently slim to get into the corners of an inner polygon. As a result, they tend to deflect and thus cause geometrical errors on the component.

All this is no longer the case when using the innovative polygon turning process. Here, the tools are almost as large as the inner polygon itself and are accordingly stable. Programming is very easy and is also supported by the INDEX polygon turning cycle.

The process shares certain features with multi-edge turning. Here, too, the workpiece and the

tool rotate around two parallel axes under an electronic speed coupling. In contrast to multi-edge turning, however, the two rotations take place in the same direction (e.g. tool rotates clockwise and workpiece rotates counterclockwise or vice versa). The polygon is ultimately created because the tool rotates faster than the workpiece and because the two axes are offset from each other by the eccentricity e . In terms of shape, these polygons are hypotrochoids. These are roulettes that are created when a circle rolls around an inner circle. A 3/4/5-sided polygon is therefore also called an H3/H4/H5 profile. These profiles can be described mathematically by the following two equations:

$$x(\theta) = (R-r) \cos(\theta) + d \cos\left(\frac{(R-r)}{r} \theta\right)$$

$$y(\theta) = (R-r) \sin(\theta) + d \sin\left(\frac{(R-r)}{r} \theta\right)$$

These polygons will be familiar to readers who owned a spirograph in childhood, because the flower-like patterns created by the spirograph (see opening picture) are mathematically exactly the same. They are also hypotrochoids. The greater

the ratio of eccentricity to the cutting circle diameter of the cutting edges, the more pointed the polygon becomes. However, the cutting wedge must then be adjusted accordingly, or the free surface will make contact. INDEX has developed its own simulation program for this purpose, allowing the cutting edge to be optimally designed for a given polygon shape. The ratio of tool to workpiece speed determines the number of corners of the polygon. The following applies:

$$n_{Wst} / n_{Wkz} = (z-1) / z$$

In terms of productivity, the process is as fast as external longitudinal turning. However, it should be noted that, for example in the case of a 3-sided polygon, only approx. 1/3 of the circumferential speed is available as the effective average cutting speed. Generally higher speeds must therefore be selected.

Thanks to the continuous cut, polygon turning is suitable for both soft and hard machining. The process can be used on all INDEX and TRAUB machines. **X**

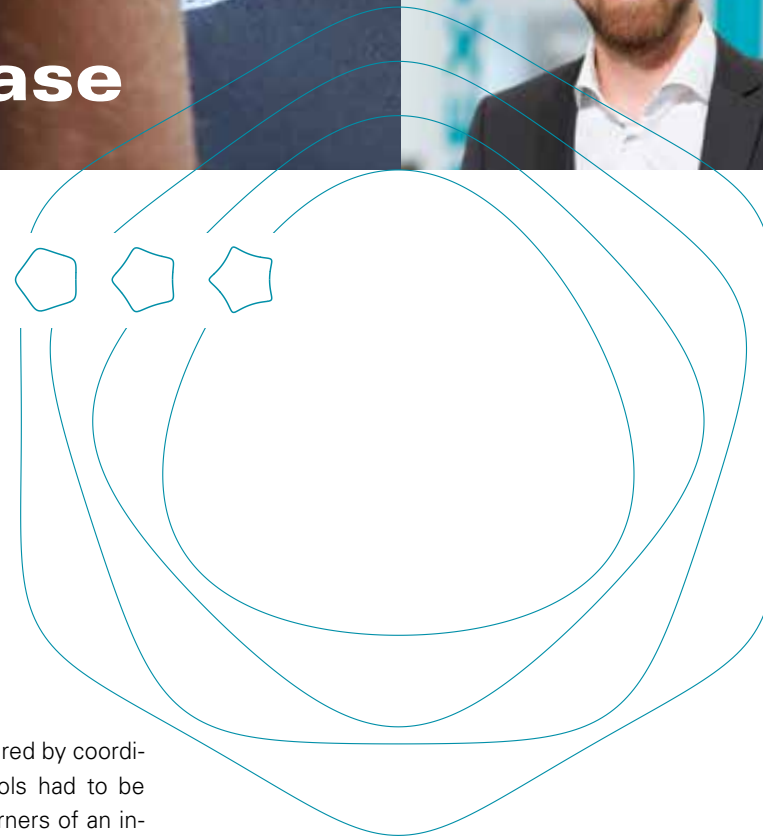

Very high torques can be transmitted in polygonal shaft/hub connections.



Reliable polygon connections are also used for spindle drives on INDEX and TRAUB machines. The picture shows the 3-sided polygon on the turret drive of the INDEX G220.

Switzerland – a small country with great potential

Since January 2019, we have had our own subsidiary in the Swiss market, enabling us to respond even more specifically to the needs of the production companies located there. Over the past two years, a well-coordinated, highly motivated team has been established to provide competent support for demanding customers in a spirit of partnership.

When we think of Switzerland, it's not just the Alps that come to mind. We also think about the highest quality, precision, and long-lasting reliability. These properties are synonymous with Swiss products and, at the same time, they require machines with the same characteristics to manufacture them. This represents an ideal field of application for machines of the INDEX and TRAUB brands, which have won over numerous Swiss customers ever since delivery of the first INDEX machine in 1920.

Philippe Dubois, Managing Director of the still young INDEX Werkzeugmaschinen (Schweiz) AG, has known the market well for over 35 years. After all, prior to the establishment of the branch office, he was the sales and marketing manager of Springmann AG, which has been INDEX's sales partner for many years. He stresses: "Whether

in the past or now, all our actions focus on customers and whatever it is they need."

Great potential

Switzerland is a high-wage country with very limited space. Accordingly, it is important to have production equipment that is characterized by productivity, precision, efficiency, high availability and top quality. "The Swiss market offers us great but also demanding development potential. This applies not only to the machines and the associated automation solutions, but also to the range of services we offer, which we are concentrating on further developing on a continuous basis," explains Philippe Dubois.

"In the field of automation, we have a large number of standard solutions in our range. However, we are also well equipped for customer-specific projects. After all, we maintain a close relationship with our parent company and enjoy excellent support from there, which benefits our customers."

Twenty-eight colleagues are currently employed in Switzerland and the number is rising. In October >



Top The Swiss branch is very close to Neuchâtel on the lake of the same name. **Left** Some of the workforce, now numbering 28 colleagues. **Right** The new premises at Innoparc St. Blaise. **Bottom** Managing Director Philippe Dubois is proud of what has been achieved so far and is ready for the challenges ahead.



The move is an important milestone on the way to further improving our efficiency and our ability to respond to market demands.

Philippe Dubois is the Managing Director of INDEX Werkzeugmaschinen (Schweiz) AG

2020, they moved into new premises in a business park at St. Blaise, which also offers good space for a demonstration room. "The move is an important milestone on the way to further improving our efficiency and our ability to respond to market demands. In addition, the machine demonstrations that are now possible make the decision process easier for our customers."

Focus on service

The Managing Director attaches particular importance to service. "Whether it's maintenance, in-production support or training – we are going to expand our customer service so that we can offer the necessary support wherever it is needed."

In particular, Swiss machining companies are welcoming the newly developed generations of the INDEX and TRAUB portfolios which are technically mature and represent the next step towards increasing productivity. "With these modern systems embedded in the digital iX-world, and with their numerous consistently benefit-oriented iX4.0 apps, users are well equipped for the future." Philippe Dubois is certain of this. X



The new INDEX sales and service location in Switzerland facilitates access to the sectors of watch/jewelry manufacturing and medical technology, as well as the automotive and aerospace industries.



News ticker



Digital machine acceptance

Special times inspire innovations. It's the same with us. We now also offer digital machine acceptance tests.

This means that you do not necessarily have to travel to us for the acceptance test on the machine you ordered. INDEX's application technicians have created the possibility of transferring the workpiece processing to you, together with measuring and logging via livestream, and of discussing the results with you directly. In addition, you can follow a large amount of status data about your machine live on the iX4.0 IoT platform. As a result, you save travel expenses and time, while still being able to be there live. Get in touch!

> www.index-traub.com/ixservices

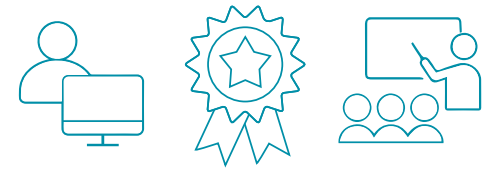

INDEX training online/offline

INDEX has always offered highly qualified basic and advanced training courses for customers' employees at its training center. After all, your machines will be even more productive if they are operated, maintained, and programmed by well-trained personnel. We have recently started offering interactive programming and operator training courses online in German and English. This reduces your costs and saves time. More information can be obtained from training@index-werke.de or by telephone: +49 711 391 525

> www.index-traub.com/training

Now find what you need even faster!

In addition to the constantly increasing number of products available in our online procurement portal, iXshop, we are regularly improving the operating functions of our platform. Besides numerous explanatory videos about our products, we have also optimized the search functions for you. You can now find spare parts and accessories even faster via your individual machine list, equipment parts list, individual parts search and watch lists. You too can go "iXshopping".

iXshop > ixshop.index-traub.com

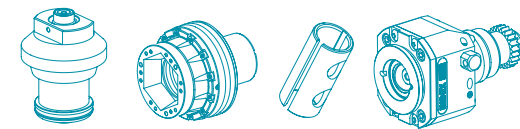

INDEX France in new premises

After 40 years, our subsidiary INDEX France has moved to new premises in the greater Paris area. At a location to the south of the French capital which enjoys good transport links, it will be possible to offer turning tests, machine demonstrations, and future customer training at a large exhibition and demonstration center.

INDEX France S.à.r.l, 12 Avenue d'Ouessant
Bâtiment I, F-91140 Villebon sur Yvette



INDEX assembly with its finger on the pulse

At our location in Reichenbach, we have concentrated and organizationally optimized the assembly procedures for single-spindle lathes. From now on, our machines will be assembled in a synchronized approach from assembly of the component groups through to the basic construction and final assembly. In particular, the upstream processes from technical clarification, order design, and procurement through to the timely link-up of internal and external suppliers, must all mesh together in the same cycle.

Assembling different series on what are called mixed lines now makes us even more flexible and we can react faster to market requirements. For our customers, this means that our planning is more stable and even more reliable in terms of delivery times.



Promotional machines available now!

You can now benefit from a wide variety of INDEX and TRAUB promotional machines that have become available at short notice. These are new, used, exhibition or demonstration machines, all with a low number of operating hours. Visit our promotional offers page and then contact us to discuss whether one of these machines would be an optimal fit for your applications.

> www.index-traub.com/demo-machines



Emphasis on training

Even amidst the current crisis, INDEX is increasingly focusing on training. In September/October this year, 45 young people at our Esslingen site will once again begin their apprenticeship or studies in technical or commercial professions. In total, we are currently training 120 apprentices/students in our training departments and specialist areas across all our locations in Germany. They are our future!

> www.index-traub.com/careers



**SAVE THE DATE:
MARCH 9-12, 2021**

OPEN HOUSE 2021

MACHINE PREMIERES

Discover the diversity of our solutions – live!

MEET THE EXPERTS

Fascinating talks on automation, “Industry 4.0,” and much else besides

GET TOGETHER

Come and see our experts in the technology lounge







MAJOR PARTNER EXHIBITION

The industry event for all aspects of machining

Visit our OPEN HOUSE 2021
at our Reichenbach location.

Save the date right now! More information on the
event will be provided with your personal invitation.
We look forward to seeing you.

Follow us around the world

-  [index-traub.com/youtube](https://www.youtube.com/index-traub.com)
-  [index-traub.com/linkedin](https://www.linkedin.com/index-traub.com)
-  [index-traub.com/xing](https://www.xing.com/index-traub.com)
-  [index-traub.com/industryarena](https://www.index-traub.com/industryarena)
-  [index-traub.com/facebook](https://www.facebook.com/index-traub.com)
-  [index-traub.com/instagram](https://www.instagram.com/index-traub.com)

Stay up to date on events and news
with our newsletter. Register now:

www.index-traub.com/newsletter

Legal notice

DREHmomente 07.2020
October 2020

PUBLISHER

INDEX-Werke GmbH & Co. KG Hahn & Tessky
Plochinger Str. 92, 73730 Esslingen, Germany
Phone: +49 (0) 711 3191-0
info@index-werke.de, www.index-werke.de

RESPONSIBLE FOR CONTENT

Reiner Hammerl

PROJECT MANAGEMENT, TEXT, LAYOUT

Rainer Gondek, Christine Sieber

PRINTING

Typodruck GmbH & Co.KG, Tuttlingen

COPYRIGHT

© 2020 INDEX-Werke GmbH & Co. KG Hahn & Tessky. All rights reserved. All images, graphics, and text is subject to copyright and other laws protecting intellectual property. No part of this publication may be copied, reproduced, or modified without express written permission from INDEX-Werke GmbH & Co. KG Hahn & Tessky.

For reasons of better readability, the masculine form has been chosen in the text, the information refers of course to both genders.

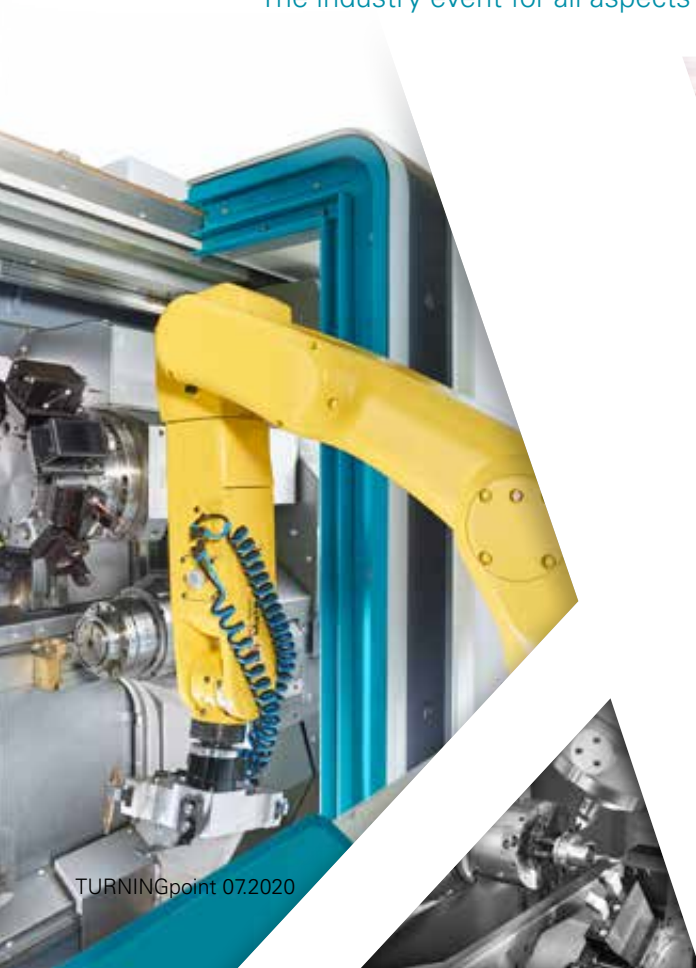

STRONG

FOR EVERY CHALLENGE AND

READY

FOR A CONNECTED WORLD



UNIVERSAL LATHES FOR PRECISE
AND POWERFUL CUTTING

Turning length: 750 mm
Speed max.: 4,000 rpm
Chuck max.: 315 mm
Torque max.: 920 Nm

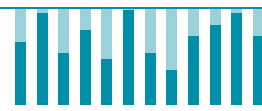
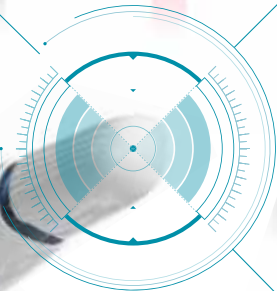

The multifunctional quartet:
INDEX B400, B500 and TRAUB TNA400, TNA500

Flexible universal lathes for precise and powerful machining.
Optionally with counter spindle and other attractive options.

www.index-traub.com

INDEX
TRAUB

better.parts.faster.